

1. WYRZUTNIA DACHOWA TYP A WG BN-70/8865-31 - WYRZ-A

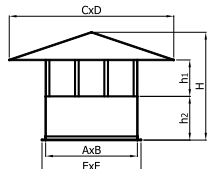

A x B	250x250	250x400	250x630	400x400	400x630	630x630	630x1000	1000x1000
C x D	450x450	290x640	540x920	720x720	800x1030	1130x1130	1250x1620	1800x1800
E x F	290x290	290x440	290x670	440x440	440x670	690x690	690x1060	1060x1060
H	475	525	590	580	670	740	885	996
h1	300	300	350	300	360	300	300	300
h2	100	120	140	160	200	250	320	400



WYRZ - AxB - TYP-A - m



Zastosowanie	P	P	P - procesy przemysłowe
Material	OC	-	OC - blacha ocynkowana
	-	X	X - blacha chromoniklowa 1.4301

2. WYRZUTNIA DACHOWA TYP B WG BN-70/8865-31 - WYRZ-B



A x B	250x250	250x400	250x630	400x400	400x630	630x630	630x1000	1000x1000
C x D	320x320	320x470	320x700	470x470	470x700	700x700	700x1070	1070x1070
E x F	290x290	290x440	290x670	440x440	440x670	690x690	690x1060	1060x1060
H	515	520	520	640	640	760	765	1130
h1	315	320	320	320	320	320	325	330

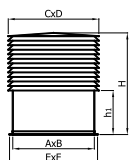

WYRZ - AxB - TYP-B - m

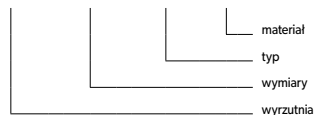

Zastosowanie	P	P	P - procesy przemysłowe
Material	OC	-	OC - blacha ocynkowana
	-	X	X - blacha chromoniklowa 1.4301

3. WYRZUTNIA DACHOWA TYP C WG BN-70/8865-31 - WYRZ-C



ø dw	160	200	250	315	350	400	500	630
ø D	320	400	500	630	700	800	1000	1260
ø B	192	233	283	352	387	438	538	670
ø A	222	263	313	378	413	464	564	714
H	320	340	425	535	595	680	850	1070
h1	200	200	250	315	350	400	500	630
h2	60	60	75	95	110	120	150	190

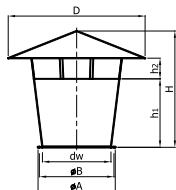

WYRZ - x - TYP-C - m



Zastosowanie	P	P	P - procesy przemysłowe
Material	OC	-	OC - blacha ocynkowana
	-	X	X - blacha chromoniklowa 1.4301

4. WYRZUTNIA DACHOWA TYP D WG BN-70/8865-31 - WYRZ-D

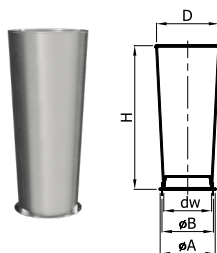

ø dw	160	200	250	315	350	400	500	630
ø D	210	260	325	410	455	520	650	820
ø B	192	233	283	352	387	438	538	670
ø A	222	263	313	378	413	464	564	714
H	480	600	750	945	1050	1200	1500	1890

WYRZ - x - TYP-D - m

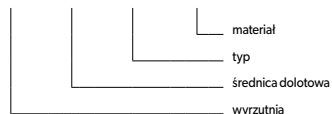

Zastosowanie	P	P	P - procesy przemysłowe
Material	OC	-	OC - blacha ocynkowana
	-	X	X - blacha chromoniklowa 1.4301

5. WYRZUTNIA DACHOWA TYP E WG BN-70/8865-31 - WYRZ-E

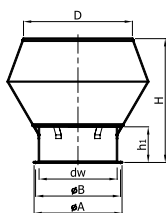

ø dw	160	200	250	315	350	400	500	630
ø D	250	280	350	440	490	560	700	880
ø B	192	233	283	352	387	438	538	670
ø A	222	263	313	378	413	464	564	714
H	300	375	430	500	555	600	715	1000
h1	150	150	150	150	150	150	150	150

WYRZ - x - TYP-E - m



Zastosowanie	P	P	P - procesy przemysłowe
Material	OC	-	OC - blacha ocynkowana
	-	X	X - blacha chromoniklowa 1.4301

6. CZERPNI A DACHOWA TYP A WG BN-70/8865-33 - CZERP-A

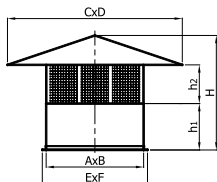

A x B	250x250	250x400	250x630	400x400	400x630	630x630	630x1000	1000x1000
C x D	450x450	490x640	540x920	720x720	800x1030	1130x1130	1250x1620	1800x1800
E x F	290x290	290x440	290x670	440x440	440x670	690x690	690x1060	1060x1060
H	525	590	665	660	715	870	1035	1195
h1	300	300	300	300	300	300	300	300
h2	150	185	215	240	245	380	470	600

CZERP - Ax B - TYP-A - m



Zastosowanie	P	P	P - procesy przemysłowe
Material	OC	-	OC - blacha ocynkowana
	-	X	X - blacha chromoniklowa 1.4301

7. CZERPNI B DACHOWA TYP B WG BN-70/8865-33 - CZERP-B

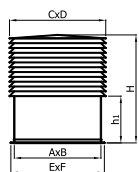

A x B	250x250	250x400	250x630	400x400	400x630	630x630	630x1000	1000x1000
C x D	320x320	320x470	320x700	470x470	470x700	700x700	700x1070	1070x1070
E x F	290x290	290x440	290x670	440x440	440x670	690x690	690x1060	1060x1060
H	515	520	570	640	640	760	765	1130
h1	315	320	320	320	320	320	325	330

CZERP - Ax B - TYP-B - m

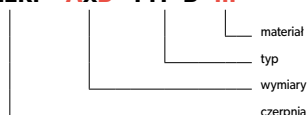

Zastosowanie	P	P	P - procesy przemysłowe
Material	OC	-	OC - blacha ocynkowana
	-	X	X - blacha chromoniklowa 1.4301

8. CZERPNI C DACHOWA TYP C WG BN-70/8865-33 - CZERP-C

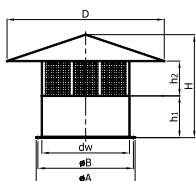

ø dw	160	200	250	315	350	400	500	630
ø D	290	360	450	570	630	720	900	1140
ø B	192	233	283	352	387	438	538	670
ø A	222	263	313	378	413	464	564	714
H	445	480	525	585	630	720	900	1040
h1	300	300	300	300	300	300	300	300
h2	95	120	150	190	210	240	300	380

CZERP - Ax B - TYP-C - m

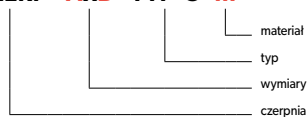

Zastosowanie	P	P	P - procesy przemysłowe
Material	OC	-	OC - blacha ocynkowana
	-	X	X - blacha chromoniklowa 1.4301

9. WYWIETRZAK CYLINDRYCZNY WG BN-66/8865-13 - WCG

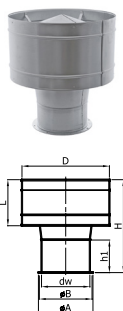

ø dw	160	200	250	315	350	400	500	630
ø D	320	400	500	630	700	800	1000	1260
ø B	192	233	283	352	387	438	538	670
ø A	222	263	313	378	413	464	564	714
H	475	495	580	690	725	825	1000	1270
h1	210	155	155	155	155	155	200	200
L	192	240	300	378	420	480	600	756

WCG - x - m - BN

- material
- średnica dolotowa
- wywietrzak cylindryczny

Zastosowanie	P	P	P - procesy przemysłowe
Material	OC	-	OC - blacha ocynkowana
	-	X	X - blacha chromoniklowa 1.4301

10. PODSTAWA DACHOWA TYPU BI - POD-BI

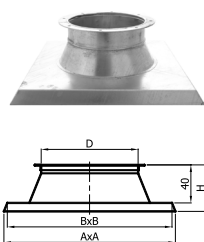

Średnica D	ø110	ø125	ø150	ø160	ø200	ø250	ø300	ø315	ø350	ø400	ø500	ø630
A	306	317	418	446	456	516	580	640	660	706	830	960
B	266	277	378	406	416	476	540	600	620	666	790	920
H	85	85	98	105	115	125	135	145	160	165	190	230

POD - x - BI - m

- material
- typ
- średnica
- podstawa

Zastosowanie	P	P	P - procesy przemysłowe
Material	X	-	X - blacha chromoniklowa 1.4301
	-	OC	OC - bl. czarna cynkowa ognioowo

11. PODSTAWA DACHOWA TYPU BII - POD-BII

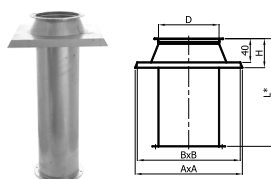

Średnica D	ø110	ø125	ø150	ø160	ø200	ø250	ø300	ø315	ø350	ø400	ø500	ø630
A	306	317	418	446	456	516	580	640	660	706	830	960
B	266	277	378	406	416	476	540	600	620	666	790	920
H	85	85	98	105	115	125	135	145	160	165	190	230

POD - x - BII - m

- material
- typ
- średnica
- podstawa

Zastosowanie	P	P	P - procesy przemysłowe
Material	X	-	X - blacha chromoniklowa 1.4301
	-	OC	OC - bl. czarna cynkowa ognioowo

* standardowo L=1000 [mm] inne wymiary na zamówienie klienta

12. PODSTAWA DACHOWA TYPU BIII - POD-BIII

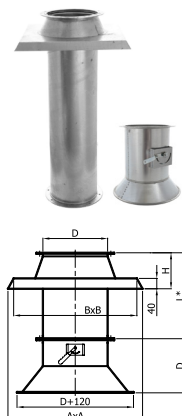

Średnica D	ø110	ø125	ø150	ø160	ø200	ø250	ø300	ø315	ø350	ø400	ø500	ø630
A	306	317	418	446	456	516	580	640	660	706	830	960
B	266	277	378	406	416	476	540	600	620	666	790	920
H	85	85	98	105	115	125	135	145	160	165	190	230

* standardowo L=1000 [mm] inne wymiary na zamówienie klienta

POD - x - BIII - m

- material
- typ
- średnica
- podstawa

Zastosowanie	P	P	P - procesy przemysłowe
Material	X	-	X - blacha chromoniklowa 1.4301
	-	OC	OC - bl. czarna cynkowa ognioowo

13. MISKA NA SKROPLINY DO PODSTAWY DACHOWEJ BIII - MS-POD

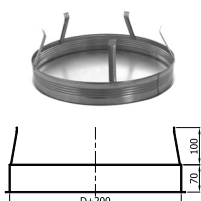

Średnica D	ø110	ø125	ø150	ø160	ø200	ø250	ø300	ø315	ø350	ø400	ø500	ø630
------------	------	------	------	------	------	------	------	------	------	------	------	------

MS - x - POD - m

- material
- podstawa dachowa
- średnica podstawy dachowej
- miska na skropliny

Zastosowanie	P	P	P - procesy przemysłowe
Material	X	-	X - blacha chromoniklowa 1.4301
	-	OC	OC - bl. czarna cynkowana

14. PODSTAWA DACHOWA Z IZOLACJĄ - WPD

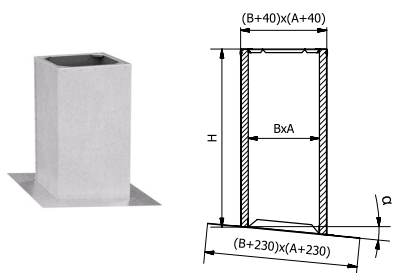

A [mm]	200	220	250	270	320	370	420	500	600
B [mm]	200	220	250	270	320	370	420	500	600

WPD - Ax B/H/α - OC / BIII



Zastosowanie	P	P - procesy przemysłowe
Materiał	OC	OC - bl. ocynkowana / wełna mineralna z włóknem szklanym

Podstawa dachowa do budowy przejść dachowych pod podstawy dachowe wentylacyjne typ A i B.

15. PODSTAWA DACHOWA Z IZOLACJĄ - WPDT-I

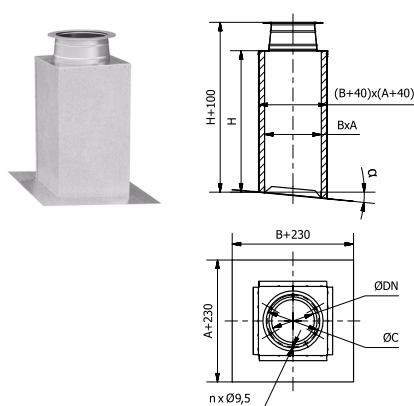

A [mm]	220	270	320	370	420	500	600
B [mm]	220	270	320	370	420	500	600
C [mm]	182	233	283	337	392	438	538
n	6	6	8	8	8	8	8
DN [mm]	150	200	250	300	350	400	500

WPDT-I - Ax B/H/α - OC



Zastosowanie	P	P - procesy przemysłowe
Materiał	OC	OC - bl. ocynkowana / wełna mineralna z włóknem szklanym

16. PODSTAWA DACHOWA Z IZOLACJĄ I RURĄ - WPDT-II

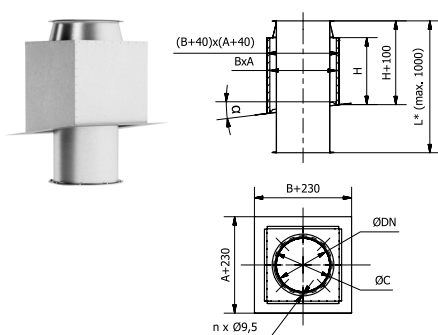

A [mm]	220	270	320	370	420	500	600
B [mm]	220	270	320	370	420	500	600
C [mm]	182	233	283	337	392	438	538
n	6	6	8	8	8	8	8
DN [mm]	150	200	250	300	350	400	500

WPDT-II - Ax B/H/α - OC

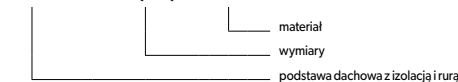

Zastosowanie	P	P - procesy przemysłowe
Materiał	OC	OC - bl. ocynkowana / wełna mineralna z włóknem szklanym

* standardowo L=1000 [mm] inne wymiary na zamówienie klienta

17. PODSTAWA DACHOWA Z IZOLACJĄ I PRZEPUSTNICĄ - WPDT-III

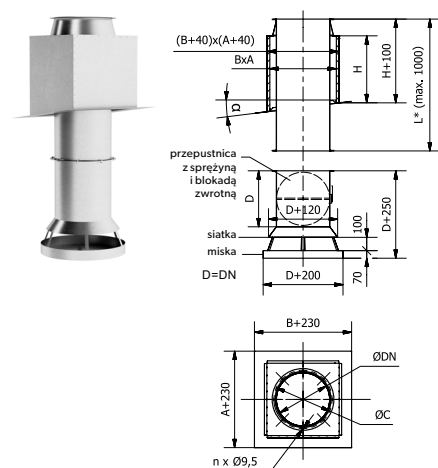

A [mm]	220	270	320	370	420	500	600
B [mm]	220	270	320	370	420	500	600
C [mm]	182	233	283	337	392	438	538
n	6	6	8	8	8	8	8
DN [mm]	150	200	250	300	350	400	500

WPDT-III - Ax B/H/α - OC

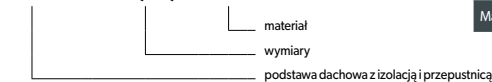

Zastosowanie	P	P - procesy przemysłowe
Materiał	OC	OC - bl. ocynkowana / wełna mineralna z włóknem szklanym

* standardowo L=1000 [mm] inne wymiary na zamówienie klienta

18. PODSTAWA DACHOWA TYPU AI WG BN-70/8865-32 - POD-AI

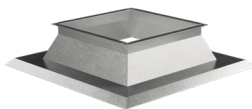

A x B	250x250	250x400	250x630	400x400	400x630	630x630	630x1000	1000x1000
C x D	490x490	490x640	490x870	665x665	665x745	945x945	945x1410	1410x1410
E x F	530x530	530x680	530x910	705x705	705x985	985x985	985x1450	1450x1450
H	145	145	145	170	170	220	220	320

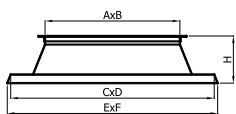

POD - AxB - AI - m

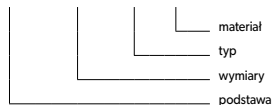

Zastosowanie	P	P	P - procesy przemysłowe
Material	X	-	X - blacha chromoniklowa 1.4301
	-	OC	OC - bl. czarna cynkowana ogniowo

19. PODSTAWA DACHOWA TYPU AII WG BN-70/8865-32 - POD-AII

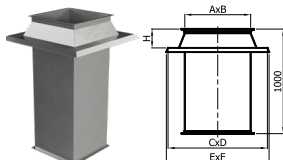

A x B	250x250	250x400	250x630	400x400	400x630	630x630	630x1000	1000x1000
C x D	490x490	490x640	490x870	665x665	665x745	945x945	945x1410	1410x1410
E x F	530x530	530x680	530x910	705x705	705x985	985x985	985x1450	1450x1450
H	145	145	145	170	170	220	220	320

POD - AxB - AII - m

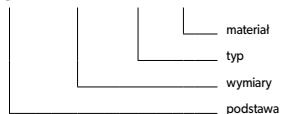

Zastosowanie	P	P	P - procesy przemysłowe
Material	X	-	X - blacha chromoniklowa 1.4301
	-	OC	OC - bl. czarna cynkowana ogniowo